

Rohs

REV.	DESCRIPTION	DRAW.	DATE.
A0	NEW RELEASE	Y.C.ZHANG	2025/07/20

SPECIFICATIONS:

- ELECTRICAL CHARACTERISTICS:
  - 1-1.RATING: 5A/Pin DC 20V
  - 1-2.CONTACT RESISTANCE: 30mΩ
  - 1-3.DIELECTRIC WITHSTANDING VOLTAGE: 500V AC FOR ONE MINUTE
  - 1-4.INSULATION RESISTANCE: 500MΩ , MEASURED BY 500V DC
- LIFE TEST:MECHANICAL LIFE TEST 5,000 CYCLES.
- TEMPERATURE RISE : 30°C MAX

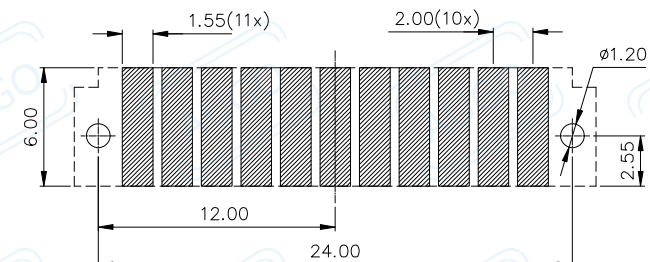
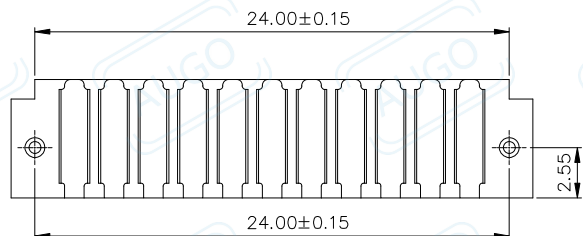
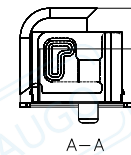
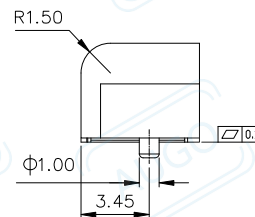
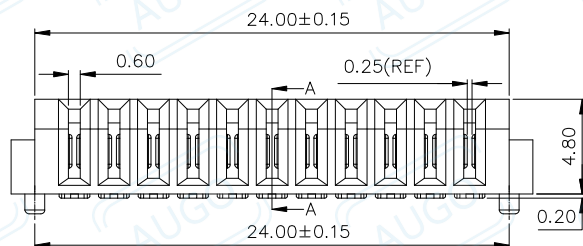
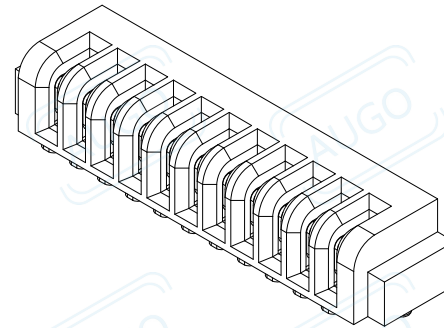
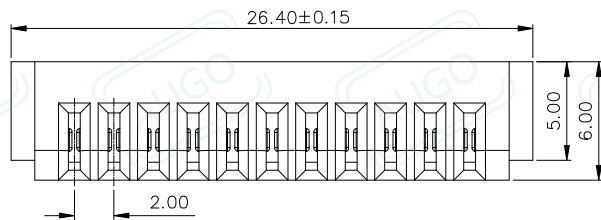

RECOMMENDED PCB LAYOUT  
T=1.2MM,TOLERANCES±0.05MM

**AUGO**

东莞市欧高电子有限公司  
Dongguan Augo Electronics Co.,Ltd  
地址:广东省东莞市黄江镇新市东江路8号富江创园 电话:0769-83383791

REV:	01
SIZE:	A4
SCALE: 1:1	UNIT: mm
SHEET: 1/1	

UNLESS OTHERWISE SPECIFIED,TOLERANCE:	
X.	±0.30
X.x	±0.25
X.xx	±0.20
ANGULAR	±2°

TITLE:	BATTERY MALE 2.0PITCH BOARD TO BOARD CONNECTOR
PART NO.:	AUGO-A06F-A-11P-SMT

DESIGN	G.C.CHEN	DATE	2025/07/18
DRAWING	Y.C.ZHANG	DATE	2025/07/18
CHECK	D.J.WANG	DATE	2025/07/20
SCALE	1:1	PAGE	1 OF 1

COPYRIGHT RESERVED,PLEASE DO NOT COPY.