

Rohs

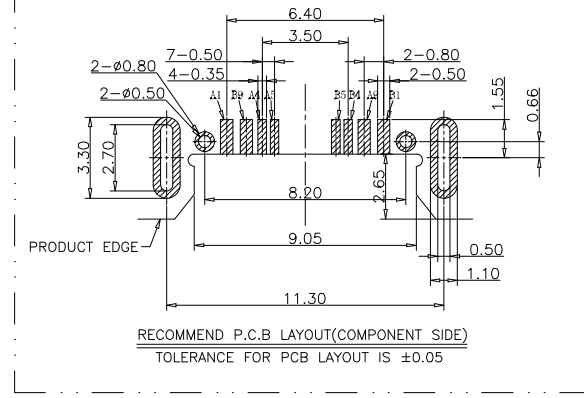

REV.	DESCRIPTION	DRAW.	DATE.

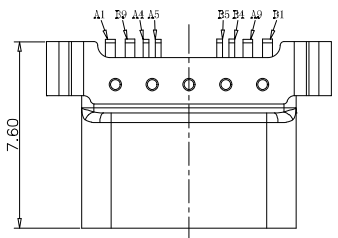

- 备注(NOTE):
- 电气特性:
 - 接触区: 接触电阻40mΩ Max, 允许10mΩ变化量. 测试条件: 20mv, 100mA下测量.
 - 接触电流: 3A VBUS引脚; 1.25A用于GND引脚; 其他引脚为0.25A.
 - 额定电压: 30V.
 - 耐电压: 100VR.M.S.
 - 绝缘电阻: 至少100兆欧.
 - 机械性能:
 - 插入力: 0.51-2.04Kg
 - 拔出力: 0.82-2.04Kg
 - 耐久性: 0.61-2.04Kg
 - 插拔次数: 10000次
 - 工作环境: -20℃ to +85℃.

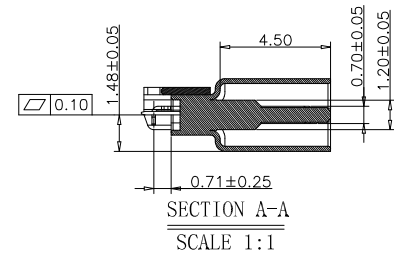
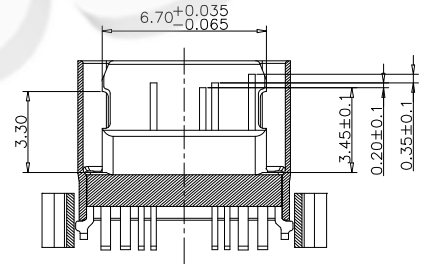
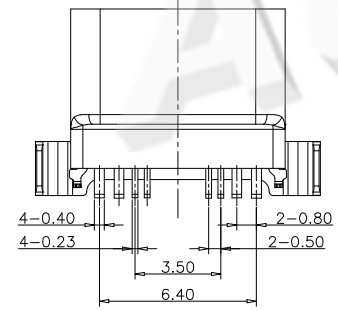
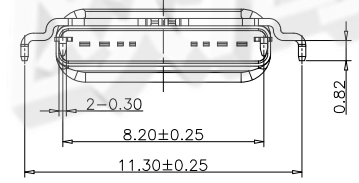
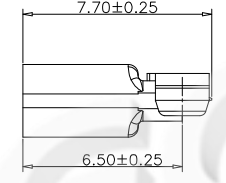
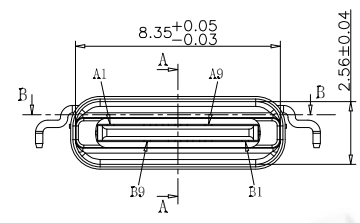

USB TYPE C PIN ASSIGNMENTS

PIN NUMBER	SIGNAL NAME	PIN NUMBER	SIGNAL NAME
A1	GND		
A4	VBUS	B9	VBUS
A5	CC1		
		B5	CC2
A9	VBUS	B4	VBUS
		B1	GND

TABLE:

NO	PART	QTY	Material
1	SHELL-1	1	STAINLESS STEEL,Ni PLATED 30u"Min
2	SHELL-2	1	STAINLESS STEEL,Ni PLATED 30u"Min
3	CONTACT	8	COPPER STEEL,Ni 50u"Min;Au u"
4	MID PLATE	1	STAINLESS STEEL,NO PLATING
5	MD HOUSING	1	HIGH TEMPERATURE RESISTANT PLASTIC BLACK UL94 V-0

AUGO

AUGO ELECTRONICS CO.,LTD.

REV:	01	UNLESS OTHERWISE SPECIFIED,TOLERANCE:
SIZE:	A4	
SCALE:1:1	UNIT:mm	X. ±0.20
SHEET:1/1	⊕	X.x ±0.15
		X.xx ±0.10
		ANGULAR ±2°

TITLE:	TYPE-C SERIES
PART NO:	TYPE C 8P 防水母座 拉伸壳两脚护套L=7.6MM

DESIGN	H.Y.ZHU	DATE	
DRAWING	W.B.QIAO	DATE	
CHECK	G.C.CHEN	DATE	
SCALE	1:1	PAGE	1 OF 1

COPYRIGHT RESERVED,PLEASE DO NOT COPY.