

Rohs

REV.	DESCRIPTION	DRAW.	DATE.

NOTES:

SPECIFICATION:

- CURRENT RATING: 3.0A MAX
- VOLTAGE: 100 VAC
- TEMPERATURE RANGE: -30°C~+85°C
- CONTACT RESISTANCE: 40 MILLIONHM MAX
- INSULATION RESISTANCE: 100 MEGOHMS MIN
- INSERTION FORCE: 5N~20N
- UNMATING FORCE: 8N~20N
- DURABILITY: 10000 CYCLES
- WATER PROOFNESS: THIS PRODUCT IS BASED ON IPX7.

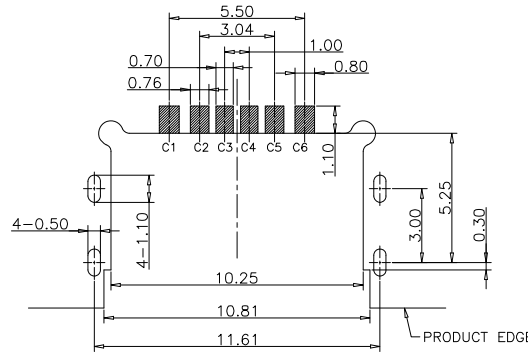
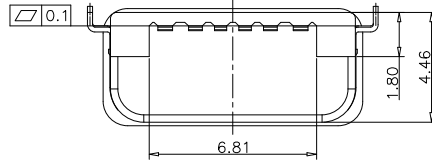

RECOMMEND P.C.B LAYOUT (COMPONENT SIDE)
TOLERANCE FOR PCB LAYOUT IS ±0.05

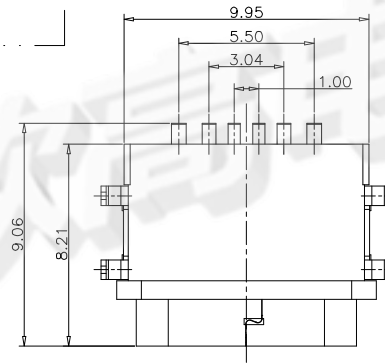
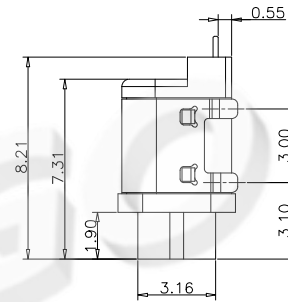
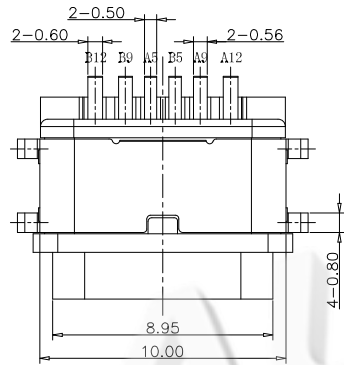

TYPE C 6P 沉板防水母座 (外壳4脚插板, 端子SMT)

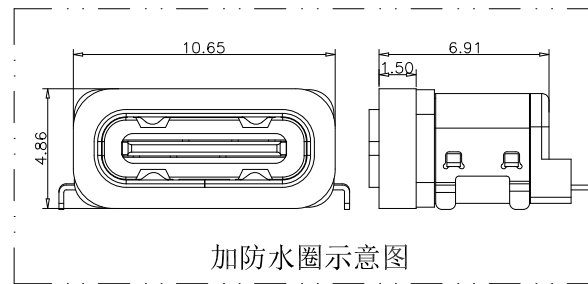
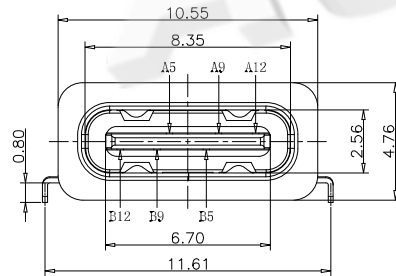
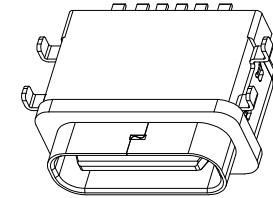
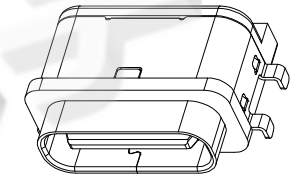

TABLE:

NO	PART	Q'TY	Material
1	SHELL	1	STAINLESS STEEL, NI PLATED
2	CONTACT	6	COPPER STEEL, TIN/Au/Ni PLATED
3	MID PLATE	1	STAINLESS STEEL, NO PLATING
4	1MD HOUSING	1	HIGH TEMPERATURE RESISTANT PLASTIC BLACK UL94 V-0
5	2MD HOUSING	1	HIGH TEMPERATURE RESISTANT PLASTIC BLACK UL94 V-0
6	SHIELDING PLATE	1	STAINLESS STEEL, NI PLATED

PIN ASSIGNMENT:

PIN NO	A1&B12	A4&B9	A5	B5	A9&B4	A12&B1
SIGNAL NAME	GND	VBUS	CC1	CC2	VBUS	GND
PCB PAD NO.	C1	C2	C3	C4	C5	C6

AUGO

AUGO ELECTRONICS CO.,LTD.

REV: 01

SIZE: A4

SCALE: 1:1 UNIT: mm

SHEET: 1/1

UNLESS OTHERWISE SPECIFIED, TOLERANCE:

X. ±0.20

X.x ±0.15

X.xx ±0.10

ANGULAR ±2°

TITLE:

TYPE-C SERIES

PART NO:

TYPE C 6P 沉板防水母座
外壳四脚插板 端子SMD

DESIGN

H.Y.ZHU

DATE

DRAWING

W.B.QIAO

DATE

CHECK

G.C.CHEN

DATE

SCALE

1:1

PAGE

1 OF 1

COPYRIGHT RESERVED, PLEASE DO NOT COPY.