

Rohs

REV.	DESCRIPTION	DRAW.	DATE.

NOTES:
 SPECIFICATION:
 1.CURRENT RATING: 3.0A MAX
 2.VOLTAGE: 100 VAC
 3.TEMPERATURE RANGE: -30°C~+85°C
 4.CONTACT RESISTANCE: 40 MILLIONHM MAX
 5.INSULATION RESISTANCE: 100 MEGOHMS MIN
 6.LNSERTION FORCE: 5N~20N
 7.UNMATING FORCE: 8N~20N
 8.DURABILITY: 10000 CYCLES
 9.WATER PROOFNESS: THISPRODUCTIS BASED ON IPX7.

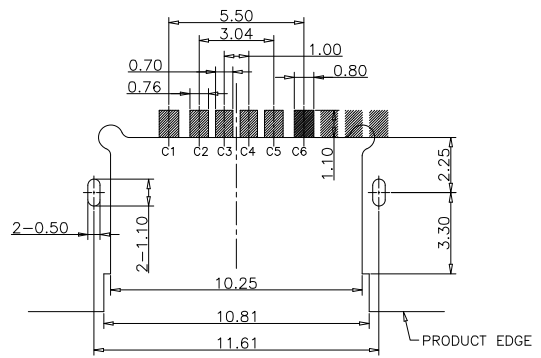
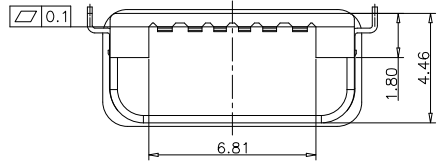

RECOMMEND P.C.B LAYOUT (COMPONENT SIDE)
 TOLERANCE FOR PCB LAYOUT IS ±0.05

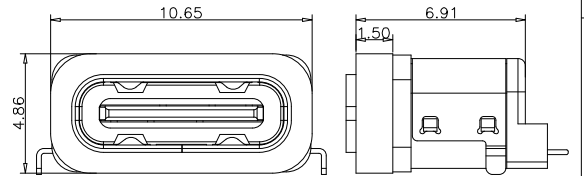
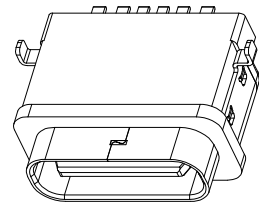
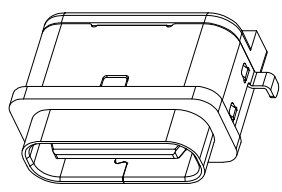
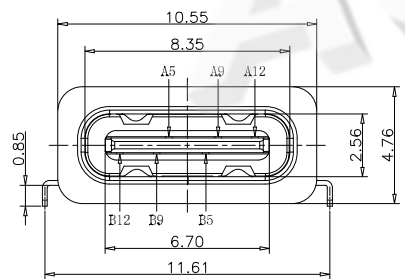
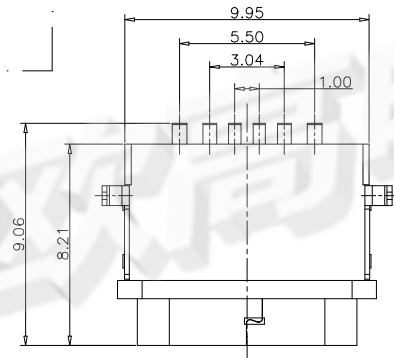
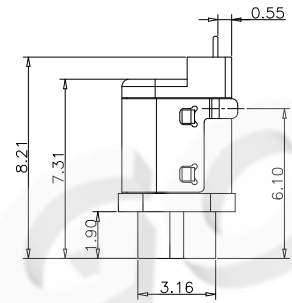
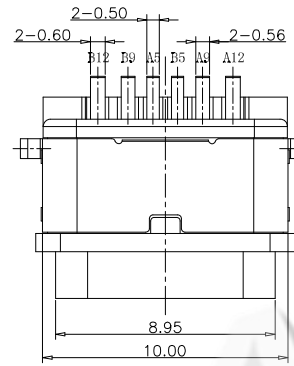

加防水圈示意图

PIN ASSIGNMENT:

PIN NO	A1&B12	A4&B9	A5	B5	A9&B4	A12&B1
SIGNAL NAME	GND	VBUS	CC1	CC2	VBUS	GND
PCB PAD NO.	C1	C2	C3	C4	C5	C6

TABLE:

NO	PART	Q'TY	Material
1	SHELL	1	STAINLESS STEEL,NI PLATED
2	CONTACT	6	COPPER STEEL,TIN/Au/NI PLATED
3	MID PLATE	1	STAINLESS STEEL,NO PLATING
4	1MD HOUSING	1	HIGH TEMPERATURE RESISTANT PLASTIC BLACK UL94 V-0
5	2MD HOUSING	1	HIGH TEMPERATURE RESISTANT PLASTIC BLACK UL94 V-0
6	SHIELDING PLATE	1	STAINLESS STEEL,NI PLATED

AUGO

AUGO ELECTRONICS CO.,LTD.

COPYRIGHT RESERVED,PLEASE DO NOT COPY.

REV: 01	UNLESS OTHERWISE SPECIFIED,TOLERANCE:	TITLE: TYPE-C SERIES	DESIGN	H.Y.ZHU	DATE	
SIZE: A4	X. ±0.20	PART NO: TYPE C 6P 沉板防水母座 外壳两脚插板, 端子SMD	DRAWING	W.B.QIAO	DATE	
SCALE:1:1	X.x ±0.15		CHECK	G.C.CHEN	DATE	
UNIT:mm	X.xx ±0.10		SCALE	1:1	PAGE	1 OF 1
SHEET:1/1	ANGULAR ±2°					