

RoHS  
Compliant

SYMBOL	REVISION	APPROVAL	DATE

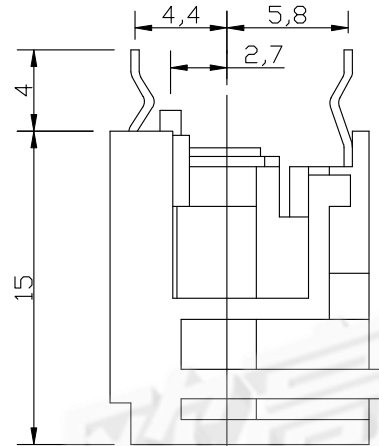
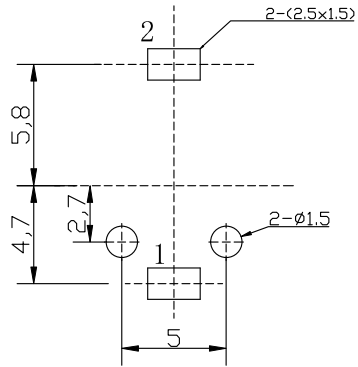
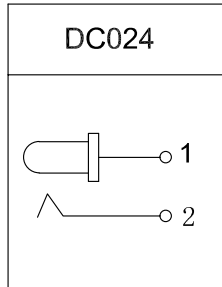

主要技术性能

1. 额定电负荷：30V 1.0A;
2. 接触电阻： $\leq 0.03\Omega$ ;
3. 绝缘电阻： $\geq 100M\Omega$ ;
4. 耐压：AC500V (50Hz) min;
5. 插拔力：3-15N;
6. 寿命：5,000次。

主要技术要求

1. 未注线性公差：
  - 0.0-10.0mm  $\pm 0.10$ mm
  - 10.0-20.0mm  $\pm 0.15$ mm
  - 20.0-50.0mm  $\pm 0.20$ mm
2. 外观应良好，无锈蚀、裂痕、电镀不良等现象。

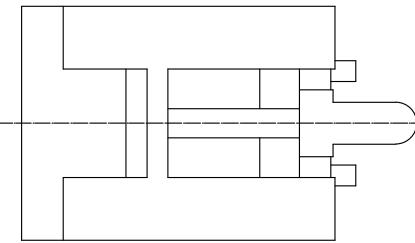
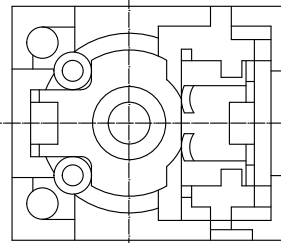
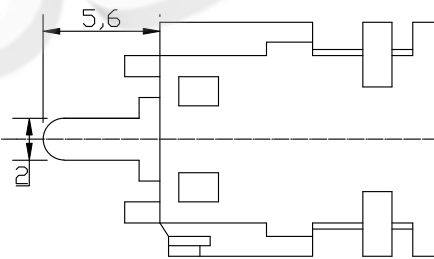
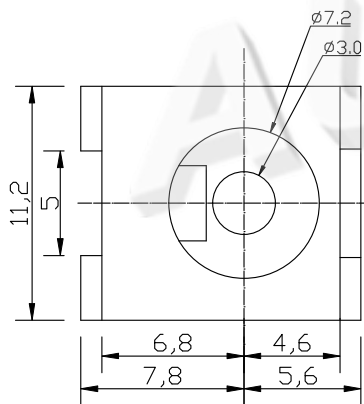

DONGGUAN AUGO ELECTRONICS CO.,LTD.

COPYRIGHT RESERVED,PLEASE DO NOT COPY.

PART NAME		DC POWER JACK		DRAWING		G.C.Chen	DWG.No.	
PART NO.		DC-024		CHECK		G.C.Chen	REV.	A
UNIT : mm	TOLERANCE OTHERWISE	UP TO 10	$\pm 0.1$	ANGLE	APPROVAL	DATE		
		ABOVE 10~20	$\pm 0.15$			SCALE	PAGE	1 OF 1
		ABOVE 20~50	$\pm 0.2$	0'±3'				